

# Imperia

Trading S.r.l.

ARTICOLO: 022  
RESTAURANT ELETTRICA  
RELEASE 3.00

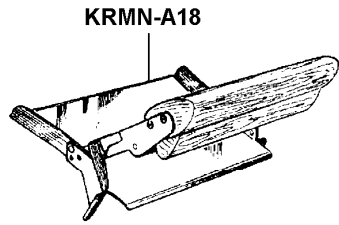

KRMN-A18

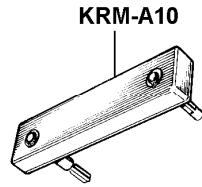

KRM-A10

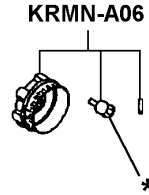

KRMN-A06

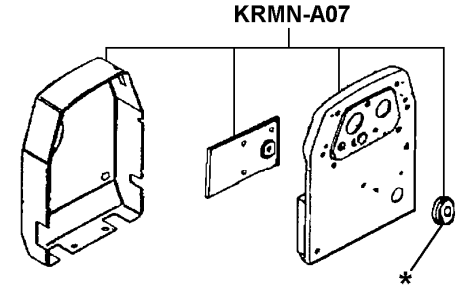

KRMN-A07

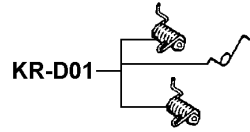

KR-D01

KR-A09

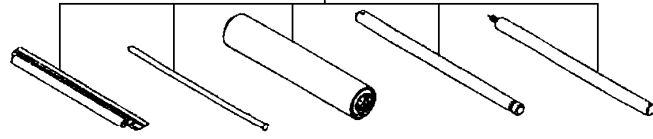

KRMN-A09

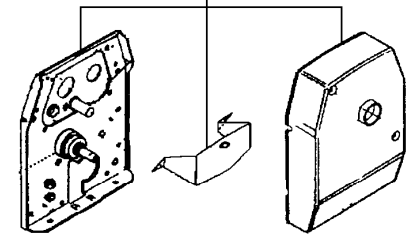

KRMN-A08

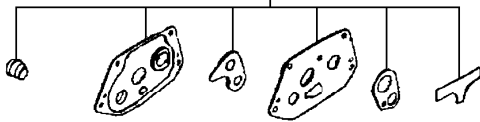

KR-A10

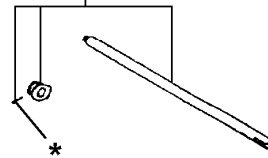

KRMN-A10

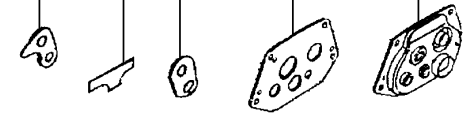

KRMN-A02

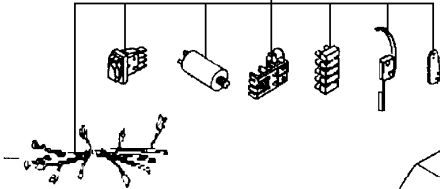

KR-A04

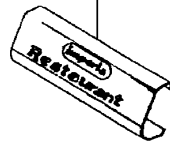

KRMN-A12

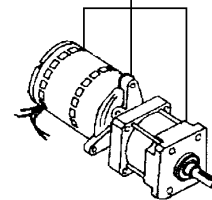

KR-A12

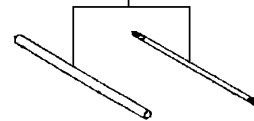

KRMN-A14

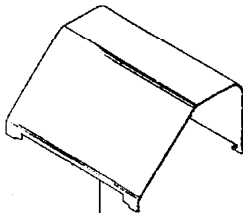

KRMN-A03

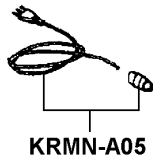

KRMN-A05

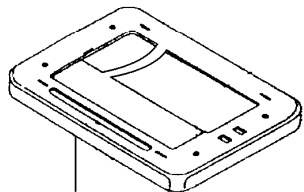

KRMN-A04

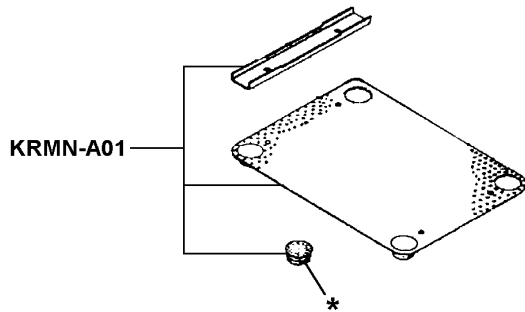



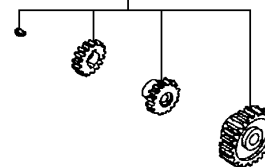

KRMN-A01

KRMN-A13

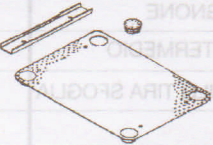
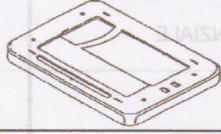
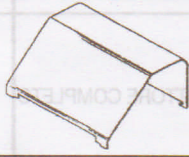
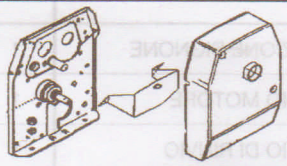
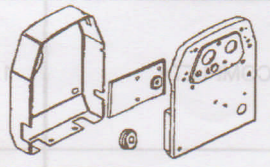

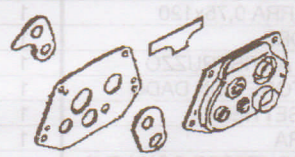
* VEDI ANCHE KIT CORRISPONDENTI SOTTOELENCATI	
CODICE	DESCRIZIONE
KRMN-E01	VARIE

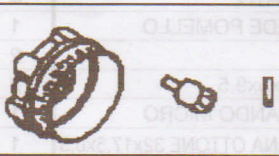
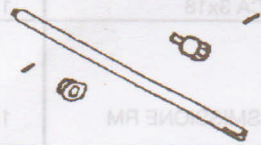
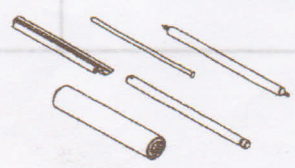
CODICE		MACCHINA SFOGLIATRICE "RESTAURANT R.M.N." 230v		
022				
DISEGNO	CODICE	DESCRIZIONE "KIT"	COMPONENTI	Q.TA'
	KRMN-A01	KIT APPOGGI	FONDO BASE	1
			SUPPORTO PIEDINI	2
			PIEDINO FORATO	4
	KRMN-A04	KIT BASE	PIASTRA BASE	1
	KRMN-A03	KIT SCIVOLATOIO	SCIVOLATOIO	1
	KRMN-A09	KIT RIVESTIMENTO LATERALE DX	FIANCO DESTRO	1
			STAFFA SOPP. PERNO	1
			CUFFIA DESTRA	1
			BOCCOLA SEDE PIGNONE	1
	KRMN-A07	KIT RIVESTIMENTO LATERALE SX	FIANCO SINISTRO	1
			COPERCHIO SCATOLA PROTEZIONE	1
			GOMMINO	2
			CUFFIA SINISTRA	1
	KR-A04	KIT GREMBIALE	GREMBIALE	1
	KRMN-A10	KIT INCASTELLATURA DX	LEVA A SQUADRA	1
			PIASTRINA DX SPALLAMENTO RULLI	1
			PIASTRINA DX SOPP. RASCHIATORE	1
			PIASTRA DESTRA	1
			SCATOLA INGRANAGGI RM COMPLETA	1
	KRMN-A08	KIT INCASTELLATURA SX	BOCCOLA ECCENTRICA	1
			CARTER SINISTRO	1
			LEVA A SQUADRA	1
			PIASTRA SINISTRA	1
			PIASTRINA SX SOPP. RASCHIATORE	1
			PIASTRINA SX SPALLAMENTO RULLI	1
	KRMN-A06	KIT POMELLO	POMELLO RMN COMPLETO	1
			BOCCOLA SEDE POMELLO FORATA	1
			SPINA ELASTICA 3x18	1
	KRMN-A11	KIT REGOLAZIONE	ASSE PORTA ECCENTRICI RMN	1
	KRMN-A09	KIT RULLI	RULLO LISCIO R.220 COMPLETO	2
			RASCHIATORE LISCIO	2
			ASSE FISSO	1
			ASTA RASCHIATORE	2
			ASSE OSCILLANTE CON CHIAVETTA	1